



PROPELLER PUMPS

ELBOW AND BOTTOM FLANGE DESIGN FOR THE PROCESS INDUSTRY



www.circorpt.com

COMMERCIAL MARINE DEFENSE OIL & GAS **POWER & INDUSTRY** RELIABILITY SERVICES





YOUR SINGLE SOURCE GLOBAL PARTNER

CIRCOR is redefining what's possible in fluid handling and process engineering applications. You're faced with demanding clients who are under increasing economic, competitive and regulatory pressures. We understand you need more than a pump. You need a partner who can help you design and deliver the most reliable, efficient and innovative solutions for both process and auxiliary applications. A partner who can provide project management and local support for global clients with facilities around the world. That's why CIRCOR surrounds you with the:

- **People:** a team of engineering and application experts, fluent in your language, who understand your business challenges and are knowledgeable about the industry
- **Products:** a portfolio of technologies, products and systems from brands you trust that increase the reliability and cost efficiency of plant operations
- **Services:** a commitment to responsive, expert levels of service that give you the support you need during design, commissioning, and throughout operations

As your single-source global supplier, we call this "Total Savings of Ownership."

BEST FIT SOLUTIONS

TECHNOLOGY YOU CAN COUNT ON

Propeller pumps are the optimal solution for moving large flow rates in industries such as chemical processing, saline and potassium mining, and food production. These pumps are available mounted horizontally on a base plate, suspended horizontally into a pipe, or mounted vertically bottom-up inside a tank.

All pumps are equipped with **state-of-the-art shaft sealings**.

ELBOW PROPELLER PUMP

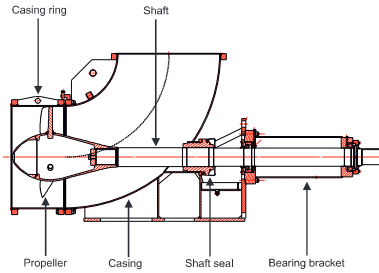

BOTTOM FLANGE PROPELLER PUMP

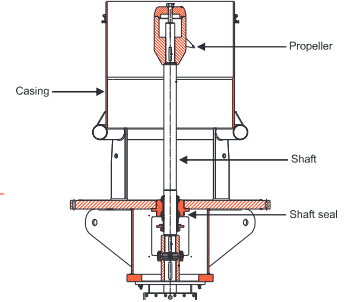

Technical Data

Flow rate: up to 50,000 m³/h

Delivery head: up to 12 m

Discharge pressure: up to 6 bar

Operating temperature: up to 200 °C

Efficiency up to 80 %

Solid content up to 40 % by weight

Wetted Materials

1.4408 equivalent to AISI 316
 1.4517 equivalent to ASTM A296 CD4MCu
 1.4588 equivalent to Alloy 926
 1.4404 equivalent to AISI 316L
 1.4462 equivalent to UNS S31803
 1.4529 equivalent to Alloy 926
 1.4562 equivalent to Alloy 31
 1.4571 equivalent to AISI 316Ti
 Nickel-based alloys

Other materials on request

Industry Products & Services

ALLWEILER® HOUTTUIN™ IMO® WARREN®

OPTIMIZED RELATED TO ... SOLVING CHALLENGING DEMANDS EXCELLENT

A variety of propeller designs give you options that are best suited to your operating conditions.

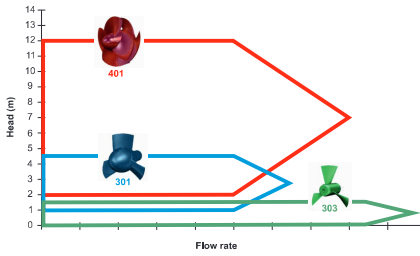

... HEAD

Large flow rate & head capabilities due to a range of propeller designs and to blades adjustable in angle

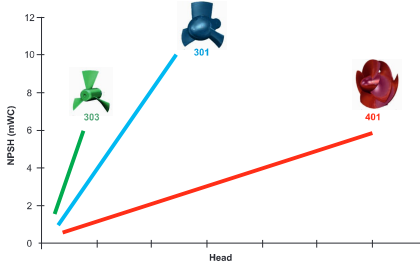

... NPSH

Optimized low NPSH requirements which minimize supply tank levels

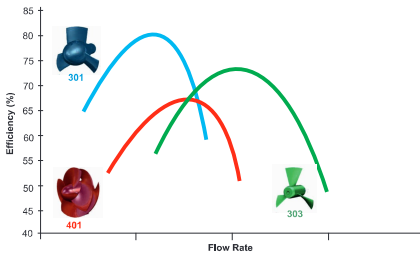

... EFFICIENCY

High overall efficiency with minimized input power requirements and driver size, achieved by minimizing gaps between blades and casing, optimizing propeller head shape and blade profile, and using a large radius elbow casing

THE EVAPORATION PROCESS IN THE SODIUM MINING INDUSTRY CIRCOR PROPELLER PUMPS PLAY AN ESSENTIAL ROLE

For decades propeller pumps from CIRCOR have provided reliable operation. A free of play bearing mounting in combination with a highly rigid shaft provide high true running accuracy and thus ensure ideal operating conditions for the shaft seal, while a spring system compensates for thermal expansion of the shaft and bracket.

An optimized rigid elbow casing, designed using Finite Element Analysis, makes them insensitive to deformation caused by pipe forces.

When pumping abrasive liquids the exchangeable casing ring guarantees low replacement costs.

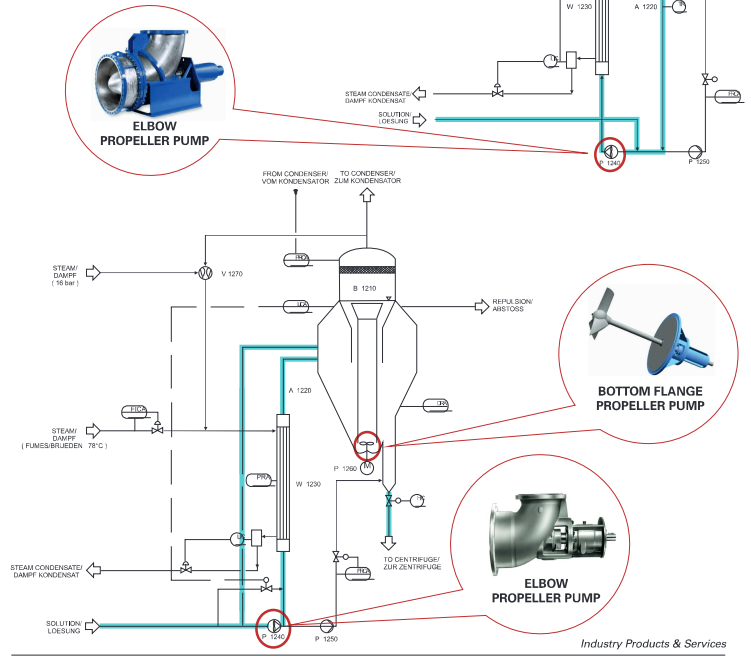



EXPERIENCE AROUND THE GLOBE

Around the globe, CIRCOR has experience and expertise in designing and applying the right fluid handling components and systems for the process engineering industry.

With its extensive product portfolio from world class manufacturers such as Allweiler, Houttuin, Imo and Warren, CIRCOR is able to draw upon 400 years of know-how in the pumping industry.

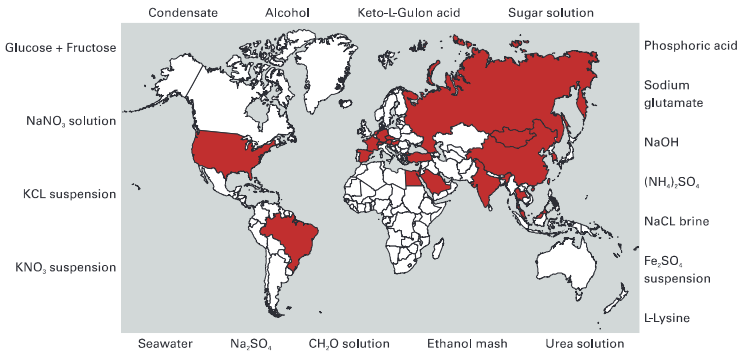

Countries where propeller pumps manufactured by CIRCOR are in operation on a variety of fluids.

CIRCOR

ALLWEILER GmbH
Allweilerstr. 1
78315 Radolfzell
Germany

1710 Airport Road
Monroe, NC 28110
USA

Unit 1803, 18/F
Clifford Centre
778 Cheung Sha Wan Road
Lai Chi Kok, Kowloon
Hong Kong

Unit 804,
Venture International Park
Building B
No. 2679 Hechuan Road
Shanghai 201103
China
Tel. +86 21 6248 1395

Tel. +49 7732 86 0

Tel. +1 704 289 65 11

Tel. +852 3473 2700

www.circopt.com



Power & Industry Products & Services

ALLWEILER® HOUTTUIN™ IMO® WARREN®

CIRCOR, ALLWEILER, IMO, TUSHACO and WARREN are registered trademarks and HOUTTUIN is a trademark of CIRCOR or its subsidiaries in the U.S. and/or other countries. (c) 2018, CIRCOR. All rights reserved. 488166 - 2018,04